

COMPUTER MODELING OF OPERATION OF EXISTING WASTEWATER
TREATMENT PLANT DURING ITS RECONSTRUCTION

Serhii Protsenko  , Mykola Kizyeyev , Olha Novytska 

National University of Water and Environmental Engineering,
11 Soborna Str., Rivne, 33028, Ukraine
s.b.protsenko@nuwm.edu.ua

<https://doi.org/10.23939/ep2023.04.263>

Received: 01.11.2023

© Protsenko S., Kizyeyev M., Novytska O., 2023

Abstract. The effectiveness of the computer modeling use of wastewater treatment processes during the implementation of planned measures was proved on the example of reconstruction of wastewater treatment plant (WWTP) of one of the large cities of Ukraine. Modeling of technological processes of wastewater treatment was performed for six modes of operation of WWTP: according to the operating technological scheme; during the implementation of four stages of its reconstruction and after the completion of all works of the reconstruction of WWTP according to new technological scheme. It is shown that, according to the technological sequence of construction and installation works adopted in the design, WWTP at all stages of its reconstruction are able to provide the standard quality of treated wastewater according to the main pollution indicators (COD, BOD₅, ammonium nitrogen, total suspended solids (TSS)). It is also shown that gradual reduction of pollution concentrations of nitrogen nitrates and phosphorus phosphates will be provided in the process of successively transferring the operation of the reconstructed WWTP according to new technological scheme and the normative requirements for their content in effluent will be achieved.

Keywords: reconstruction of WWTP, computer modeling, nitrite-denitrification, dephosphorization.

1. Introduction

A number of WWTPs in Ukraine are currently operate under unsatisfactory condition and require reconstruction with a significant change in the technology of wastewater and sludge treatment (National report on the quality of drinking water, 2021; National report on the state of environment, 2021; Protsenko et al., 2021).

One of the main problems during reconstruction of operating WWTPs is the need of temporarily decommission of certain WWTP's facilities to carry out the necessary construction and installation works. At the same time, facilities that under operation and work in the mode of increased load must provide the sufficient efficiency of wastewater treatment.

The computer modeling of wastewater treatment processes at different stages of the implementation of planned measures can provide significant help in order to assess the impact on the efficiency of the treatment plant during determining the rational technological sequence of works of the reconstruction of operating WWTP.

2. Experimental part

2.1. The design of WWTP's reconstruction

Let's consider the example of the design of WWTP's reconstruction of one of the large cities of Ukraine. The existing technological scheme of WWTP provides the wastewater treatment from coarse and mineral impurities on mechanized grids and on horizontal sand traps. After these facilities the treated wastewater is separated into two independent technological lines (it should be noted that due to the peculiarities of the topography of the WWTP's site, the facilities of the second technological line are located

slightly higher than facilities of the first technological line; this circumstance is important and significantly influenced on design decisions.

The first technological line includes four primary radial clarifiers with a diameter of 40 m (Fig. 1, 1.1–1.4), four sections of a three-corridor aeration tank with a total volume of 96,000 m³ (2.2) and six secondary radial clarifiers with a diameter of 40 m (3.1–3.6). The second technological line includes eight primary radial clarifiers with a diameter of 40 m (1.5–1.12), four sections of a four-corridor aeration tank with a volume

of 96,000 m³ (2.1) and two sections of a four-corridor aeration tank with a volume of 48,000 m³ (2.3) and ten secondary radial clarifiers with a diameter of 40 m (3.7–3.16). If necessary, the second technological line can be divided by separating into a separate line two primary clarifiers 1.11 and 1.12, the aeration tank 2.3 and two secondary clarifiers 3.15 and 3.16. Disinfection of treated wastewater before its discharge into the water reservoir is carried out by supplying chlorine water from the chlorinator to the contact well on the discharge pipeline of the plant.

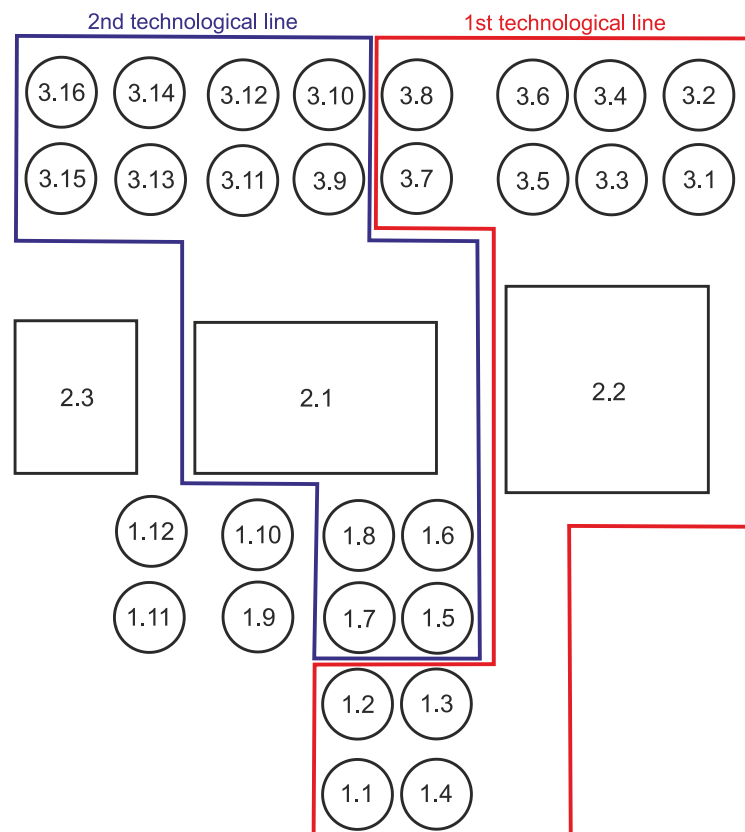

Fig. 1. The scheme of the site of the operating WWTP with the location of primary clarifiers (1.1–1.12), aeration tanks (2.1–2.3), secondary clarifiers (3.1–3.16) and with the distribution of the facilities according to technological lines after the completion of their reconstruction

One of the tasks of the reconstruction of operating WWTP is to change the technology of biological treatment of wastewater in aeration tanks in order to increase the efficiency of removing biogenic elements (nitrogen and phosphorus) to normative indicators. This necessitates the reconstruction of the operating facilities and the construction of a number of new technological and production facilities with the installation of appropriate equipment.

The design of WWTP's reconstruction includes the use of the following measures taking into account

high concentrations of biogenic elements in wastewater and a relatively low content of organic substances:

- efficiency reduction of the primary clarification of wastewater by reduction the number of operating primary clarifiers from twelve to eight (seven operating and one reserve clarifiers 1.1–1.8). The primary clarifiers 1.9–1.12 will be taken out of operation;

- application of acidification (pre-fermentation) of raw sludge in primary clarifiers, that provides the content increase of easily oxidizable organic substances in wastewater, necessary for the biological

removal of phosphorus in aeration tanks (Qasim, Zhu, 2018; van Haandel, van der Lubbe, 2012);

- implementation in aeration tanks 2.1 and 2.2 the technology which combines biological removal of nitrogen and phosphorus according to the scheme of the Johannesburg (JHB) process (Qasim, Zhu, 2018; van Haandel, van der Lubbe, 2012; Henze et al., 2008) (the aeration tank 2.3 will be taken out of operation);

- additional chemical removal of phosphorus by reagent treatment of effluent by aluminum hydroxychloride (Haandel, van der Lubbe, 2012).

Among the main measures, which will be provided by this large-scale design, it is worth noting the following:

- reconstruction of the operating grid facilities with installation of grids of coarse (preliminary) treatment with bar screens spaced 100 mm with manual debris removal and grids of fine (main) treatment with bar screens spaced 6 mm with mechanized debris removal (8 operating and 2 reserve grids of each type). At the same time, 10 grids (5 grids of each type) will be taken out of operation after completion of the reconstruction of treatment facilities;

- new construction of six aerated sand traps instead of operating horizontal ones;

- complex reconstruction of eight primary and sixteen secondary radial clarifiers with replacement of sludge removal mechanisms (scrapers and sludge pumps) and wastewater distribution and collection systems;

- implementation in aeration tanks 2.1 and 2.2 of biological nitrogen and phosphorus removal technology (nitrification-denitrification and dephosphorization technology according to JHB process scheme). The arrangement of two anoxic and one anaerobic zones with mechanical mixers, the aerobic zone with a pneumatic aeration system in each section of the aeration tanks and the organization of internal nitrate recycling of the sludge mixture from the end of the aerobic zone to the top of the second anoxic one is provided for this;

- reconstruction and new construction of pump stations, reconstruction of the air-blowing station with the installation of energy-efficient pump and air-blower equipment with a frequency-regulated drive;

- new construction of chemical feed plant (coagulant dosing station and storage tanks);

- installation of the automated system of functional control of technological processes and

remote control of technical devices to provide such control;

- complex reconstruction of sludge treatment facilities etc.

The final distribution of the main facilities of WWTP by two technological lines after the completion of its reconstruction is shown in Fig. 1.

The reconstruction design of WWTP provides the technological sequence of construction and installation works in four stages.

The following main measures are carried out at the first stage of reconstruction:

- partial reconstruction of the pressure damping chamber with the distribution channel and the grid chamber (first five grids will be reconstructed, the other ten grids are under operation);

- decommission of operating horizontal sand traps, new construction of aerated sand traps, reconstruction of hydraulic elevator chamber, new construction of sand sites;

- reconstruction of four primary clarifiers 1.1–1.4, their distribution chamber and raw sludge pump station;

- reconstruction of aeration tank 2.2;

- reconstruction of six secondary clarifiers 3.1–3.6, their distribution chambers, construction of new activated sludge pump station, while secondary clarifiers 3.7 and 3.8 are transferred to the 2nd technological line and are not used in this line;

- new construction of chemical feed plant.

The second stage of reconstruction works of WWTP includes the following main measures:

- completion of the reconstruction of the pressure damping chamber with the distribution channel and the grid chamber (the following five grids will be reconstructed, the other ten grids, including the five reconstructed ones, are under operation);

- reconstruction of four primary clarifiers 1.5–1.8, their distribution chamber and raw sludge pump station;

- reconstruction of the first two sections of aeration tank 2.1;

- reconstruction of four secondary clarifiers 3.7–3.10 and their distribution chamber;

- reconstruction of the air-blowing station.

The third stage of works includes the reconstruction of:

- the remaining two sections of the aeration tank 2.1;

- four secondary clarifiers 3.11–3.14 and their distribution chamber.

The fourth stage of works includes the reconstruction of:

- the last two secondary clarifiers 3.15 and 3.16 and their distribution chamber;
- activated sludge pump station;
- operator room in the administrative building.

2.2. Computer modeling of technological processes of wastewater treatment

In order to determine the effectiveness of biological wastewater treatment at different stages of the reconstruction of WWTP, the modeling of its operation was carried out by computer program Hydromantis GPS-X. The following design parameters of wastewater (taking into account the return flows of the plant) are: average daily wastewater discharge – 400 thousand m³/day; COD – 330 mg/dm³; BOD₅ – 156 mg/dm³; TSS – 222 mg/dm³; ammonium nitrogen (N-NH₄) – 24 mg/dm³; total nitrogen – 33.1 mg/dm³; phosphorus phosphates (P-PO₄) – 8.16 mg/dm³; total

phosphorus – 10.2 mg/dm³; the design temperature of wastewater is 12 °C.

Modeling of technological processes of wastewater treatment was performed for six modes of operation of WWTP: according to the operating technological scheme; during the implementation of four stages of its reconstruction and after the completion of all works of the reconstruction of WWTP according to new technological scheme.

The first mode of modeling provided for the operation of WWTP according to the operating technological scheme:

- all facilities of both technological lines are operated;
- the first technological line receives 40 % of wastewater, the second – the remaining 60 %;
- aeration tanks operate in the mode of full biological treatment of wastewater with regeneration of activated sludge (the volumes of regenerators make up 25 % of the total volume of each aeration tank);
- the degree of recirculation of return activated sludge from secondary clarifiers to aeration tanks is 0.4.

The result of modeling of WWTP's operation (balance diagram) according to the operating technological scheme is shown in Fig. 2.

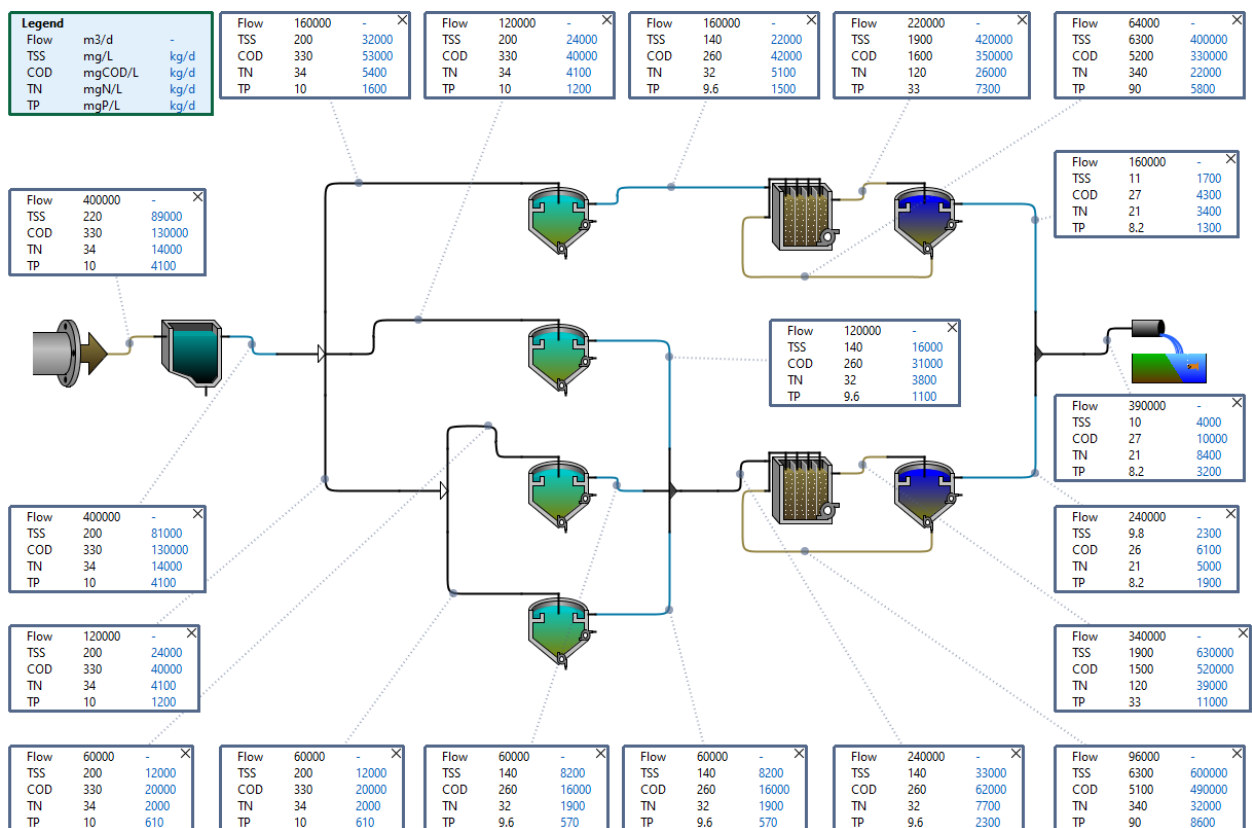

Fig. 2. The result of modeling of WWTP's operation according to the operating technological scheme: Flow – wastewater flow rate, m³/day; TSS – suspended solids, mg/dm³ and kg/day; COD – COD, mg/dm³ and kg/day; TN – total nitrogen, mg/dm³ and kg/day; TP – total phosphorus, mg/dm³ and kg/day

In the second mode, the operation of treatment facilities during the first stage of construction and installation works was modelled. At this stage, the design provides taking out of operation of all the facilities of the first technological line for their

reconstruction. The operation of the facilities of the second technological line is provided in full according to the operating technological scheme. The result of modeling of WWTP's operation at this mode is shown in Fig. 3.

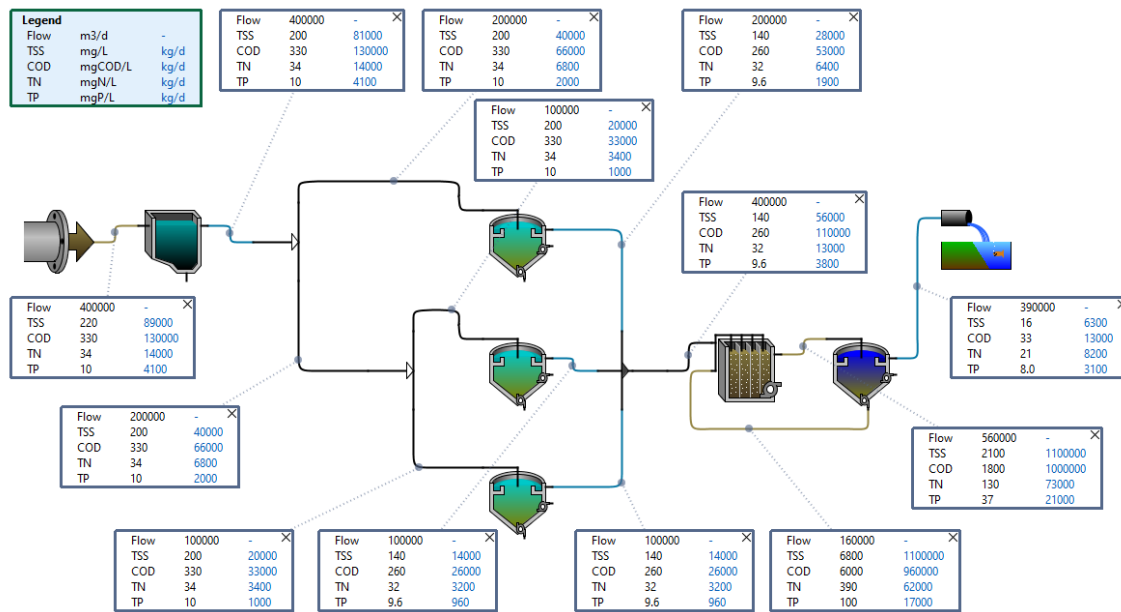

Fig. 3. The result of modeling of WWTP's operation at first stage of its reconstruction

During the second stage of construction works (third mode of modeling), the design provides taking out of operation the following main facilities of the second technological line for their reconstruction: four primary clarifiers 1.5–1.8; two first sections of the aeration tank 2.1; four secondary clarifiers 3.7–3.10. Such main facilities of the second technological line remain under operation: four primary settling tanks 1.9–1.12; two sections of aeration tank 2.1 and aeration tank 2.3; six secondary clarifiers 3.11–3.16. In addition, it is provided that the reconstruction of the facilities of the first technological line (primary clarifiers 1.1–1.4, aeration tank 2.2, secondary clarifiers 3.1–3.6) is fully completed. These facilities are put into operation according to the new technological scheme. Aeration tank 2.2 operates in the mode of biological nitrite-denitrification and dephosphorization of wastewater with four separate zones: the first anoxic zone with a total volume of all four sections of 4.400 m³, the anaerobic zone with a volume of 10,800 m³, the second anoxic zone with a volume of 12.600 m³ and the aerobic zone with a volume of 68.200 m³. The degree of internal nitrate recycling of the sludge mixture in the aeration tank 2.2 is taken as 0.7, the degree of recirculation of the return activated sludge from the secondary clarifiers 3.1–3.6 to the aeration tank 2.2 (external recycle) is 0.75. The distribution of wastewater between the first and second technological lines is carried

out in equal proportions. Wastewater coming from primary clarifiers 1.1–1.4 to aeration tank 2.2 of the first technological line is distributed between zones of the aeration tank as follows: 30 % – to the first anoxic zone; 70 % – to the anaerobic zone. The result of modeling of WWTP's operation at the second stage of its reconstruction is shown in Fig. 4.

During the third stage of works (fourth modeling mode), the design provides taking out of operation the following main facilities of the second technological line for their reconstruction: two primary clarifiers 1.9 and 1.10; the two following sections of the aeration tank 2.1; four secondary clarifiers 3.11–3.14. Such main facilities of the second technological line are under operation: two primary clarifiers 1.11 and 1.12 and four reconstructed primary clarifiers 1.5–1.8; aeration tank 2.3 and two reconstructed sections of aeration tank 2.1; two secondary clarifiers 3.15 and 3.16 and four reconstructed secondary clarifiers 3.7–3.10. Two reconstructed sections of aeration tank 2.1 operate in the mode of biological nitrite-denitrification and dephosphorization of wastewater, similar to the operation of aeration tank 2.2. The facilities of the first technological line operate in the same mode as during the implementation of the works of the second stage. Wastewater flows are distributed among the technological lines as follows: to the first technological

line – 50 %; to the second technological line – 50 % (including 30 % – to primary clarifiers 1.5–1.8; 20 % – to primary clarifiers 1.11 and 1.12). The result of modeling of WWTP’s operation at the third stage of its reconstruction is shown in Fig. 5.

The main difference in the operation of treatment facilities during the implementation of the fourth stage, compared to the third, is that two secondary clarifiers

3.15 and 3.16 are taken out of operation for reconstruction, and four reconstructed secondary clarifiers 3.11–3.14 are put into operation instead on the second technological line. The other facilities and their modes of operation remain the same as during the third stage. The balance diagram of WWTP’s operation based on the results of modeling at the fifth mode (fourth stage) is shown in Fig. 6.

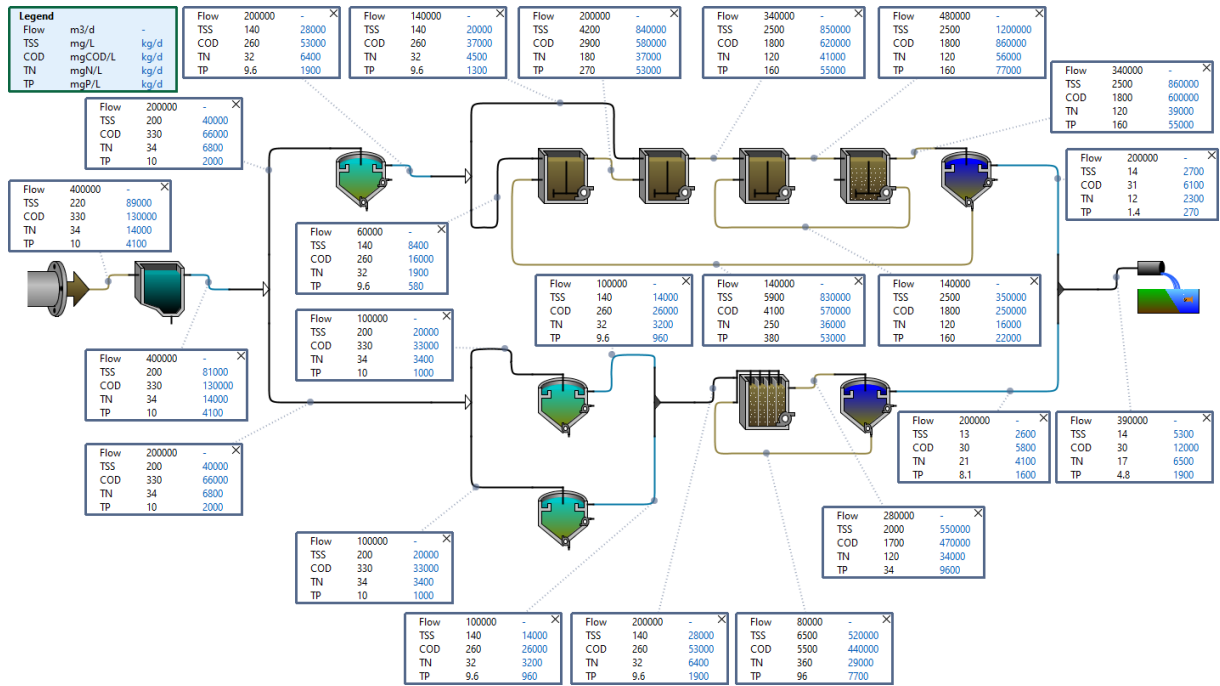

Fig. 4. The result of modeling of WWTP’s operation at second stage of its reconstruction

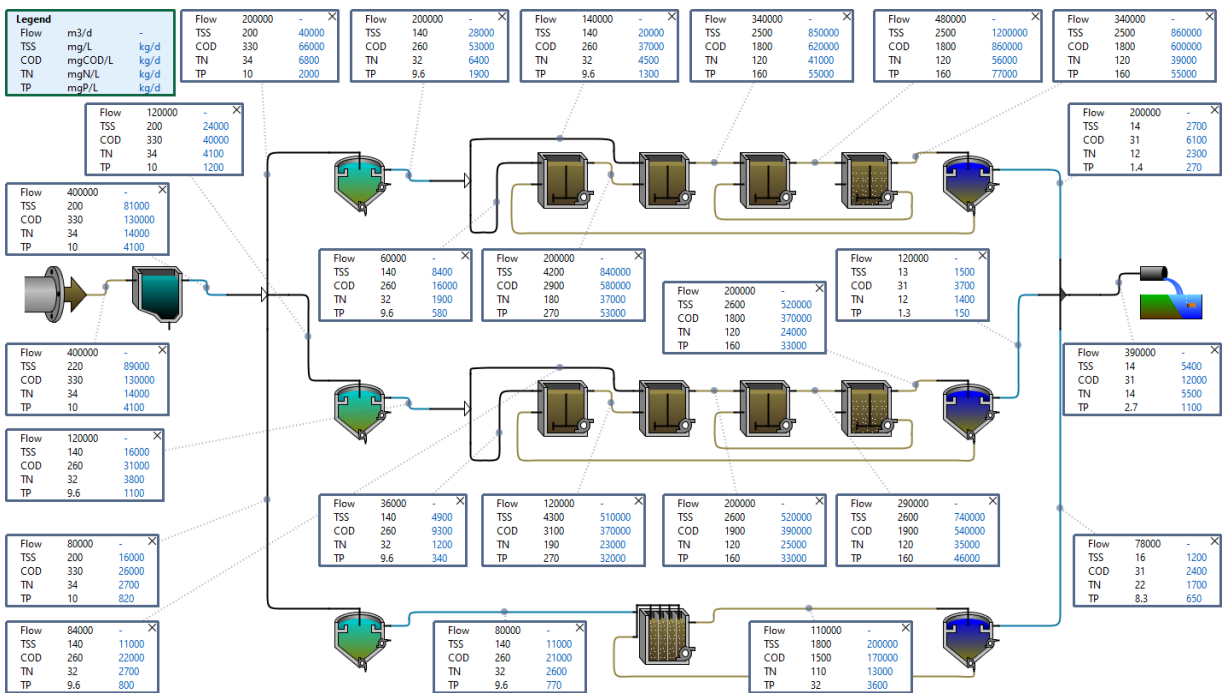

Fig. 5. The result of modeling of WWTP’s operation at third stage of its reconstruction

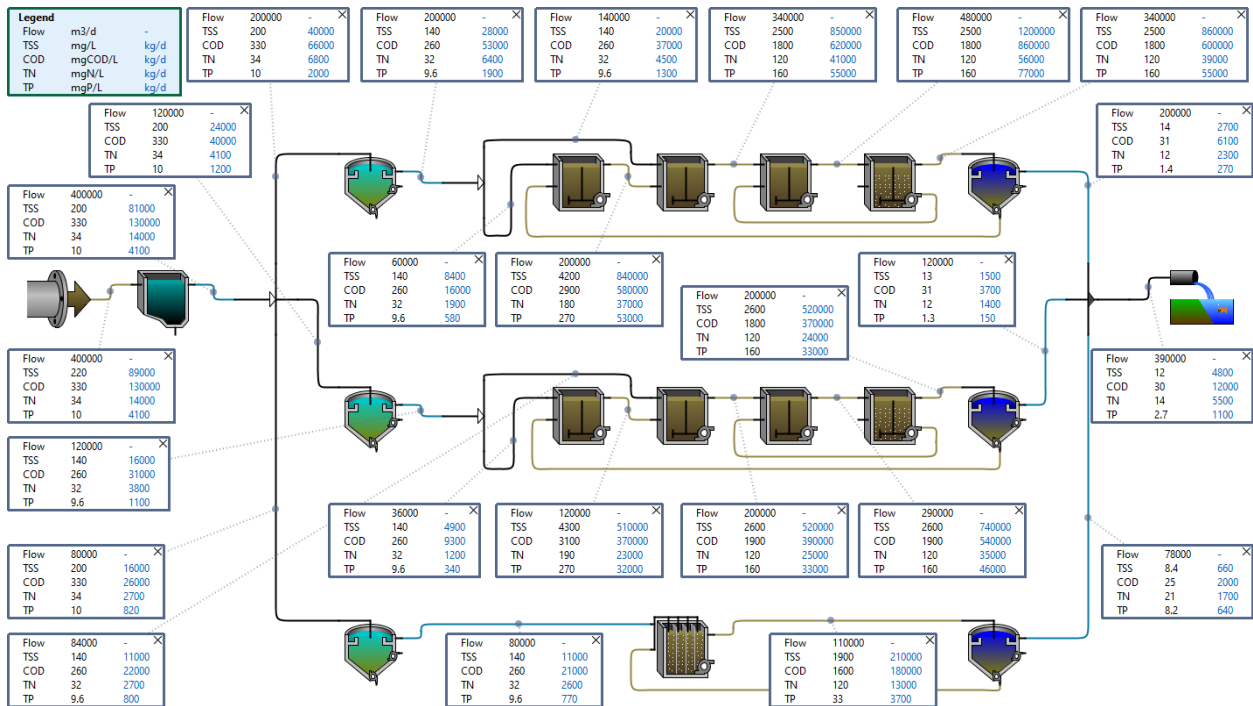

Fig. 6. The result of modeling of WWTP’s operation at fourth stage of its reconstruction

After the completion of all construction and installation works for the reconstruction of WWTP, the final technological scheme of their operation is shown in Fig. 1:

- the first technological line includes four primary clarifiers 1.1–1.4, aeration tank 2.2, eight secondary clarifiers 3.1–3.8 (the design provides pumping by vertical axial pumps the part of the sludge mixture from the aeration tank 2.2 to the secondary clarifiers 3.7 and 3.8, which are located slightly above the rest of the secondary clarifiers 3.1–3.6);
- the second technological line includes four primary clarifiers 1.5–1.8, aeration tank 2.1, eight secondary clarifiers 3.9–3.16.

Wastewater flows will be distributed among the technological lines in equal proportions. Primary clarifiers 1.9–1.12 and aeration tank 2.3 will be decommissioned. The result of modeling of WWTP’s operation after the final

completion of its reconstruction according to the new technological scheme is shown in Fig. 7.

3. Results and Discussion

The conducted research show (Table) that according to the technological sequence of works on the reconstruction of WWTP adopted in the design, it is possible to provide the standard quality of effluent according to the main indicators of pollution (COD, BOD₅, ammonium nitrogen, TSS) at all stages of the implementation of the planned measures. The reduction in the content of nitrogen nitrate and phosphorus phosphates will be provided gradually in the process of successively transferring the operation of the reconstructed facilities according to the design technological scheme and regulatory requirements for effluent quality will be achieved according to these indicators.

Indicators of the effluent quality based on the results of modeling of technological processes at different operating modes of WWTP and wastewater discharge requirements

Indicators of the effluent quality	Indicator values, mg/dm ³						
	at operating technology scheme	at first stage	at second stage	at third stage	at fourth stage	after reconstruction	wastewater discharge requirements
COD	26.5	32.7	30.4	31.2	29.9	28.9	80
BOD ₅	3.8	6.7	6.0	6.7	6.3	6.0	15
TSS	10.2	16.0	13.6	13.9	12.4	10.8	15
Ammonium nitrogen	0.15	0.27	0.87	1.48	1.47	1.42	2.0
Nitrite nitrogen	0.14	0.37	0.60	0.91	0.91	0.91	0.91
Nitrate nitrogen	19.1	17.7	12.8	9.3	9.3	7.2	10.2
Phosphorus phosphates	7.9	7.6	4.1	1.85	1.85	0.34	1.14

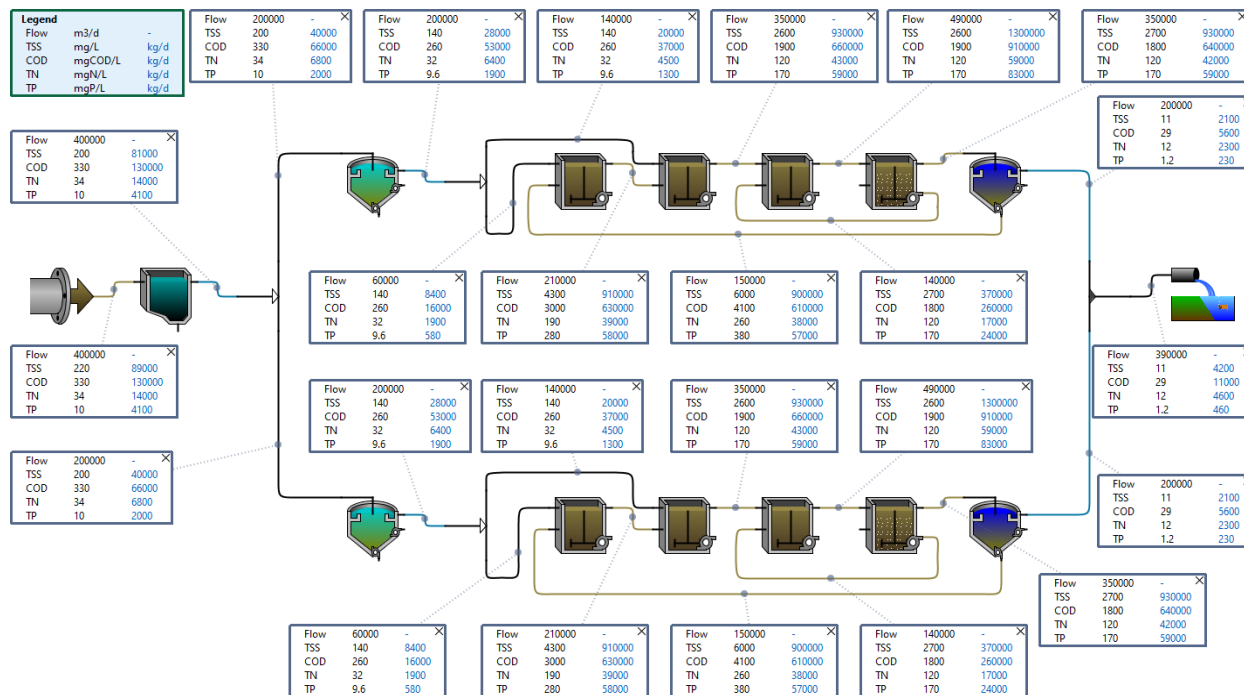

Fig. 7. The result of modeling of WWTP's operation after final completion of its reconstruction

4. Conclusions

1. One of the main problems in the reconstruction of operating WWTPs is the need to temporarily taking out of operation certain facilities of the treatment plant to carry out the necessary construction and installation works, while the facilities that remain under operation and operate under increased load, must provide the sufficient efficiency of wastewater treatment.

2. Computer modeling of wastewater treatment processes at different stages of construction can significantly help in determining the rational technological sequence of reconstruction works of operating treatment facilities.

3. The expediency of using computer modeling to assess the impact of planned measures on the efficiency of wastewater treatment was approved on the example of the reconstruction design of WWTP of one of the large cities of Ukraine.

4. The results of the conducted research showed that according to the technological sequence of construction works adopted in the project, WWTP at all stages of their reconstruction are able to provide the standard quality of effluent according to the main indicators of pollution (COD, BOD₅, ammonium nitrogen, TSS). The gradual reduction in concentrations of nitrogen nitrates and phosphorus phosphates will be provided in the process of successively transferring the work of the reconstructed facilities according to the

design technological scheme and regulatory requirements for their content in treated wastewater will be achieved.

References

- Henze, M., van Loosdrecht, M. C. M., Ekama, G. A., & Brdjanovic, D. (2008). *Biological Wastewater Treatment. Principles, Modelling and Design*. IWA Publishing. doi: <https://doi.org/10.2166/9781789060362>
- National report on the quality of drinking water and the state of drinking water supply in Ukraine in 2020. (2021). Kyiv: Ministry for Communities, Territories and Infrastructure Development of Ukraine. Retrieved from <https://mtu.gov.ua/files/Національна%20доповідь%20про%20якість%20питної%20води%20та%20стан%20питного%20водопостачання%20в%20Україні%20у%202020%20році--.pdf>
- National report on the state of environment in Ukraine in 2020 (Project). (2021). Kyiv: Ministry of Environmental Protection and Natural Resources of Ukraine.
- Protsenko, S., Kizyeyev, M., & Novytska, O. (2021). Choice of the efficient flow diagram of biological wastewater treatment at municipal wastewater treatment plants. *Journal Environmental Problems*, 6(4), 244–250. doi: <https://doi.org/10.23939/ep2021.04.244>
- Qasim, S. R., & Zhu, G. (2018). *Wastewater Treatment and Reuse. Theory and Design Examples. Vol. 1: Principles and Basic Treatment*. CRC Press, Taylor & Francis Group. doi: <https://doi.org/10.1201/b22366>
- van Haandel, A. C., & van der Lubbe, J. G. M. (2012). *Handbook of Biological Wastewater Treatment. Design and Optimisation of Activated Sludge Systems*. 2nd ed. IWA Publishing. doi: <https://doi.org/10.2166/9781780400808>